



Patterson-Kelley
HARSCO

Instructions

NURO Conversion Instructions
MACH C750-C1050

1005101709
ENVI to NURO
Date: 12/21/2017
Revision A

NOTICE!

Each safety device must be maintained and checked per the recommended schedule. Refer to Section 6 in the O&M Manual for more information.

SAFETY FEATURES

It is the responsibility of the customer to ensure external safety provisions, such as but not limited to: guards, safety labels, safety controls, interlocks, lockout devices are in place and operable.

SAFETY LABELS

The following words are used in this manual to denote the degree of seriousness of the individual hazards.

DANGER

Indicates an imminently hazardous situation which, if not avoided, will result in death or serious injury. This signal word is to be limited to the most extreme situations.

WARNING

Indicates a potentially hazardous situation which, if not avoided, could result in death or serious injury.

CAUTION

Indicates a potentially hazardous situation which, if not avoided, may result in minor or moderate injury. It may also be used to alert against unsafe practices.

NOTICE/NOTE - NOTICE

Is the preferred signal word to address practices not related to personal injury. The safety alert symbol is not used with this signal word.



Patterson-Kelley
HARSCO

Instructions

NURO Conversion Instructions
MACH C750-C1050

1005101709
ENVI to NURO
Date: 12/21/2017
Revision A

WARNING

If the information in these instructions are not followed, fire or explosion may result causing property damage, personal injury, or loss of life.

WARNING

It is essential to read, understand, and follow the recommendations of these instructions before installing, operating or servicing this equipment. Failure to do so could result in personal injury or death.

WARNING

Installation and service must be performed by a qualified and knowledgeable individual who has been certified on the P-K MACH® boiler. The features which permit this boiler to achieve high-efficiency performance can be misused which could result in personal injury or death.

WARNING

Lockout/tagout procedure must be employed when servicing this unit. Failure to do so could result in electrocution, injury, or death.

WARNING

Label all wires prior to disconnection when servicing controls. Wiring errors can cause improper and dangerous operation.

WARNING

Use care when reassembling main gas line and ensure all connections are tight. Use a leak detector to check for leaks before and after servicing any component of the gas piping. Failure to do so could result in injury or death.

WARNING

Use care when servicing boiler to prevent the accumulation of gas in or around the combustion chamber. Pockets of accumulated gas are subject to combustion and/or explosion which could result in injury or death.

WARNING

Installation must be in strict conformance to all applicable codes and standards including NFPA 54, ANSI Z223.1 and CAN/CSA B.149.

AVERTISSEMENT

Une installation, un réglage, un changement ou un entretien inappropriés peuvent causer des dommages matériels, des blessures corporelles ou la mort.

Lire et bien comprendre le Manuel d'installation et du propriétaire fourni avec cette chaudière. L'installation et le service doivent être effectués par un personnel expérimenté et compétent qui a reçu une formation sur la chaudière de cette série.



WARNING

Improper installation, adjustment, alteration, service, or maintenance can cause property damage, personal injury or loss of life.

Read and understand the installation and Owner's manual provided with this boiler. Installation and service must be performed by experienced and knowledgeable personnel who have been trained on this series boiler.



Patterson-Kelley
HARSCO

Instructions

NURO Conversion Instructions
MACH C750-C1050

1005101709
ENVI to NURO
Date: 12/21/2017
Revision A

TOOLS Required

- Phillips Head Screwdriver
- Drill and Drill Bit Set
- Adjustable Wrench
- Set of Nut Drivers SAE
- Torx set SAE
- Multimeter
- Gas Analyzer

CAUTION

Wire runs and devices connected to the Air Damper Interlock, Auxiliary Input, or Start Interlocks MUST be rated for 120 VAC.

NOTE: Analog input for the NURO controller must be 4-20mA.

NOTE: DHW Flow switch terminals are not available.

NOTE: If Cascading multiple appliances, convert all to NURO controls for ideal operation.

NOTE: If using a Protocol Converter or MODBUS, contact the factory for support.

1. Lock out Tag out all electrical connections and gas supply to appliance. There may be multiple power sources.
2. Remove side and top panels held on by Phillips head screws and set aside.
3. Remove terminal block covers. Identify and label all current field wiring on boiler when disconnecting.



Patterson-Kelley
HARSCO

Instructions

NURO Conversion Instructions
MACH C750-C1050

1005101709
ENVI to NURO
Date: 12/21/2017
Revision A

4. Drill out 6 rivets from back of each of terminal boxes holding them in place shown in figure 2.



Figure 1



Patterson-Kelley
HARSCO

Instructions

NURO Conversion Instructions
MACH C750-C1050

1005101709
ENVI to NURO
Date: 12/21/2017
Revision A

5. Remove 9 3/8" nuts from right front door shown in figure 2 and after removing right side panel, re-use insert shown in figure 3 below on right side frame.



Figure 2



Figure 3



Patterson-Kelley
HARSCO

Instructions

NURO Conversion Instructions
MACH C750-C1050

1005101709
ENVI to NURO
Date: 12/21/2017
Revision A

6. Remove 8 Phillips head screws from ENVI door to remove left grey swinging door shown in figure 4.



Figure 4



Patterson-Kelley
HARSCO

Instructions

1005101709

ENVI to NURO

Date: 12/21/2017

Revision A

NURO Conversion Instructions MACH C750-C1050

7. Remove 20 Phillips head screws to remove left panel from front cabinet shown in figure 5.

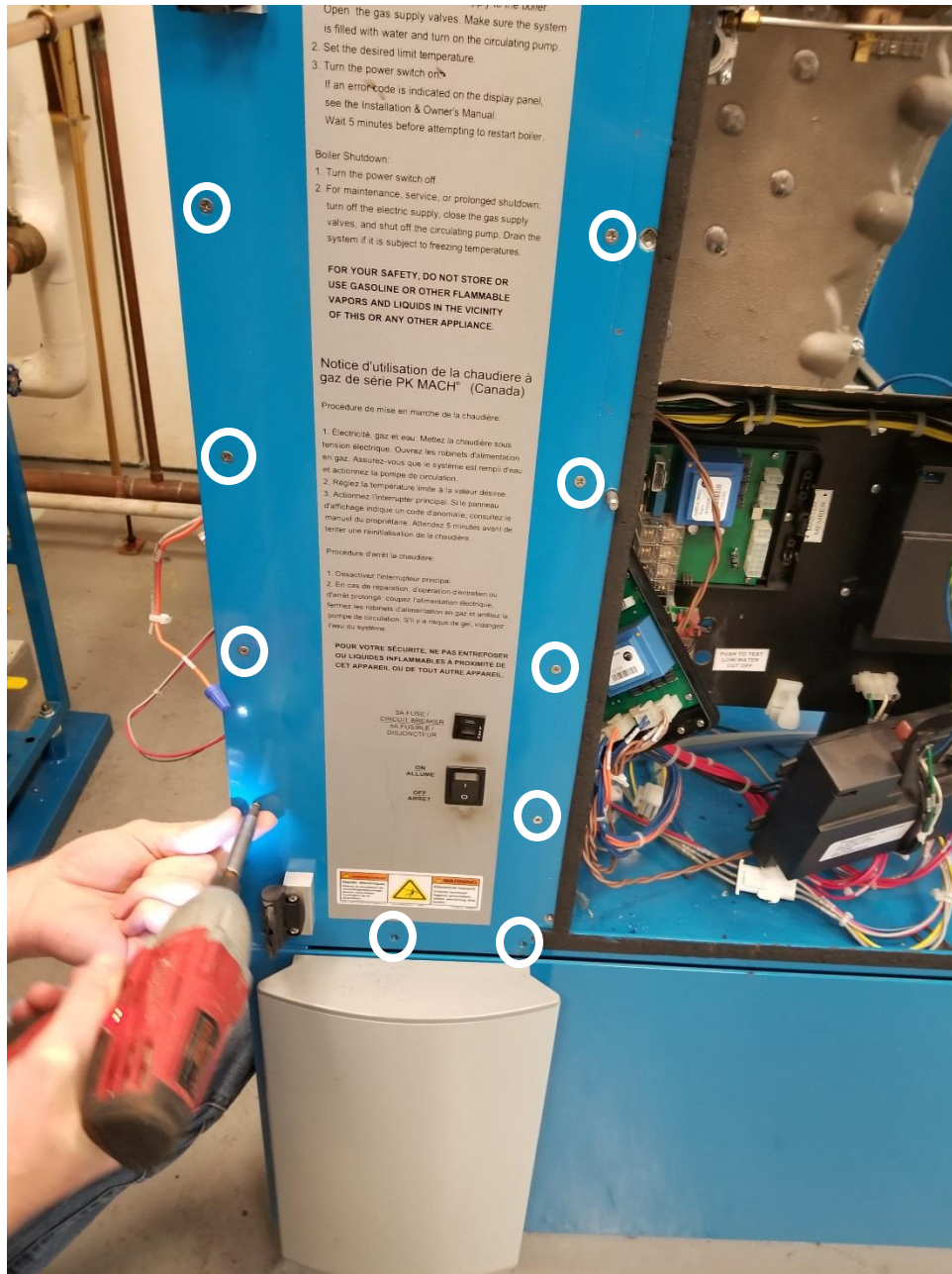

Figure 5



Patterson-Kelley
HARSCO

Instructions

NURO Conversion Instructions
MACH C750-C1050

1005101709

ENVI to NURO

Date: 12/21/2017

Revision A

8. Remove 2 Phillips head screws located at top and bottom of vertical bar shown in figure 6.

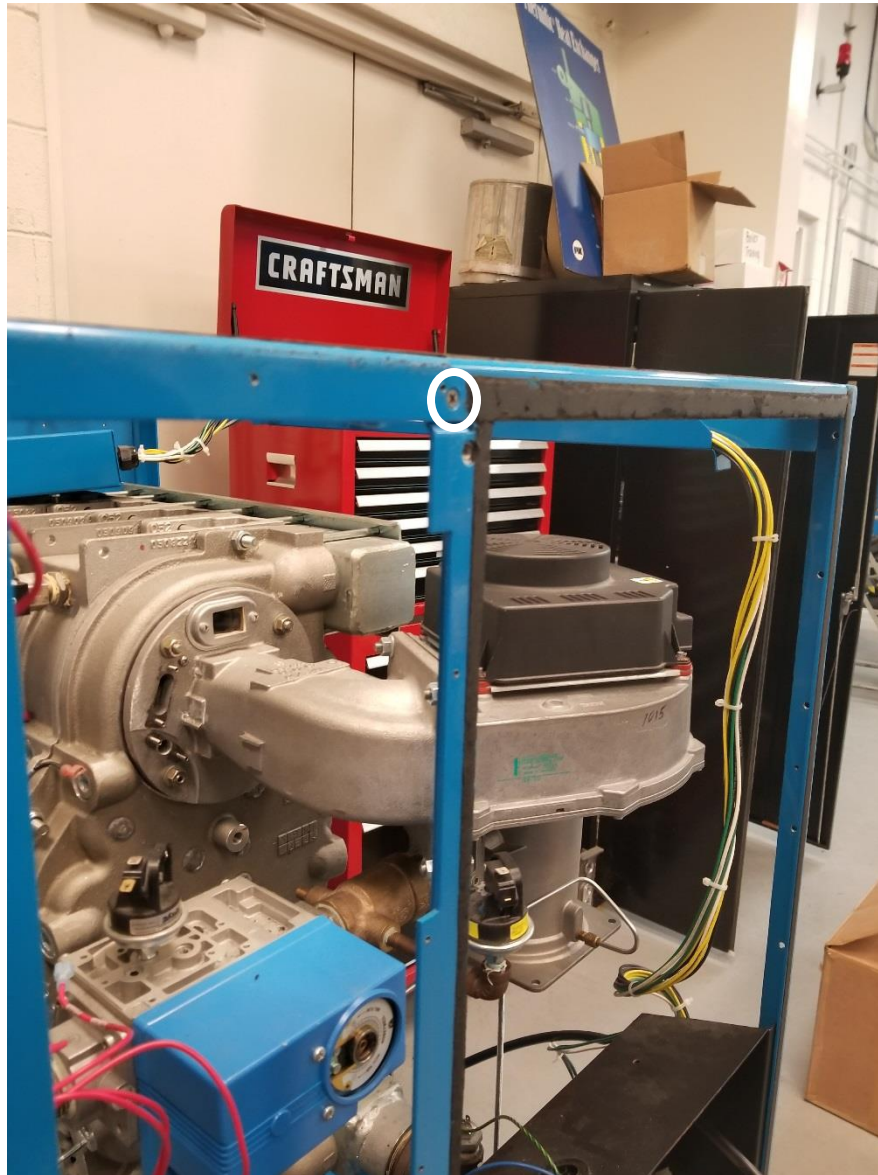

Figure 6



Patterson-Kelley
HARSCO

Instructions

1005101709

ENVI to NURO

Date: 12/21/2017

Revision A

NURO Conversion Instructions MACH C750-C1050

9. Disconnect all wires from internal safety devices and sensors. Take note to wire colors for sensors as new panel will use same colors for sensor wires.
10. Remove 4 11/32" nuts on control panel and remove from cabinet shown in figure 7.

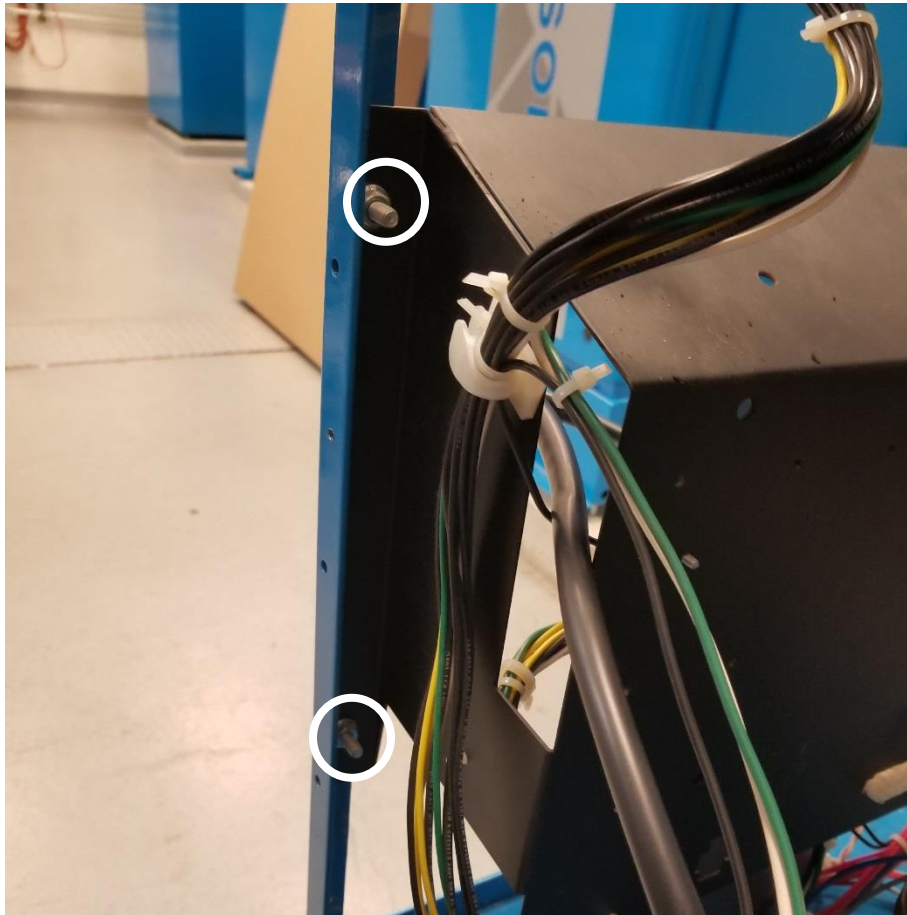

Figure 7



Patterson-Kelley
HARSCO

Instructions

NURO Conversion Instructions
MACH C750-C1050

1005101709

ENVI to NURO

Date: 12/21/2017

Revision A

11. Remove existing high and low gas pressure switches.

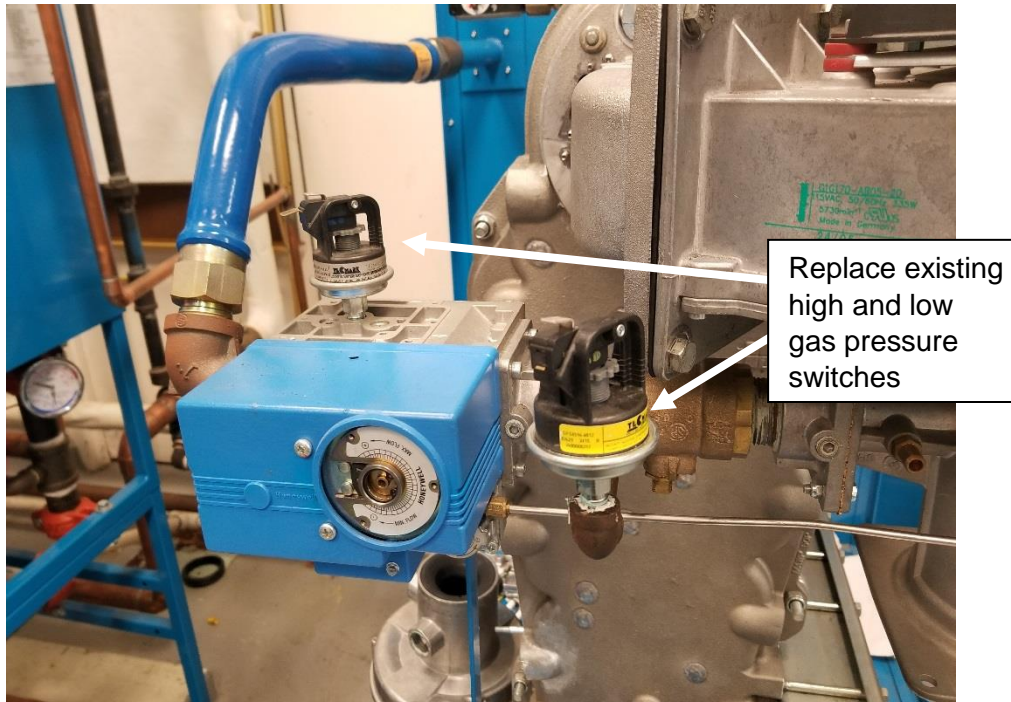

Figure 8

12. In order to install high gas pressure switch, remove stem and install high gas pressure switch onto stem. Then reinstall stem shown in figure 9. Be sure to apply gas thread sealant to new switches

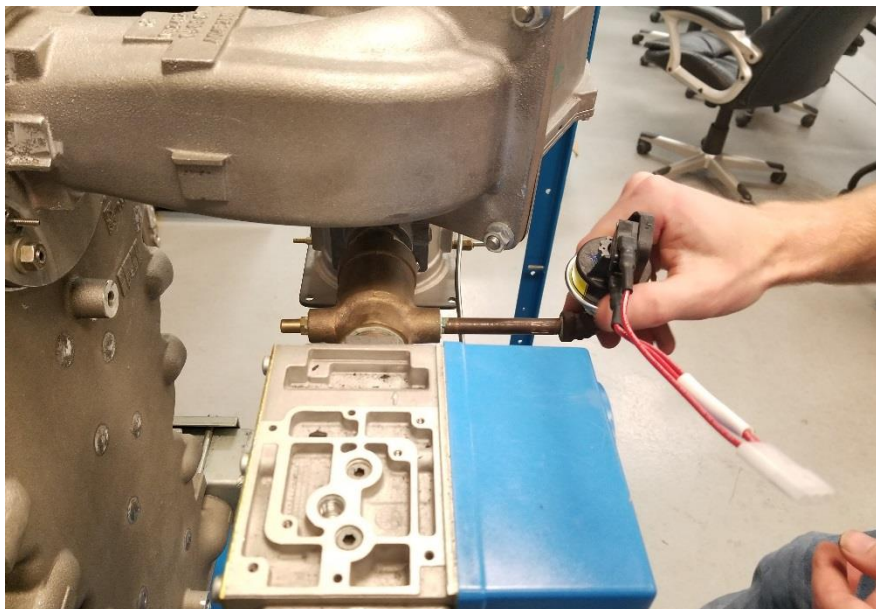

Figure 9



Patterson-Kelley
HARSCO

Instructions

NURO Conversion Instructions
MACH C750-C1050

1005101709

ENVI to NURO

Date: 12/21/2017

Revision A

13. Install low gas pressure switch shown in figure 10.

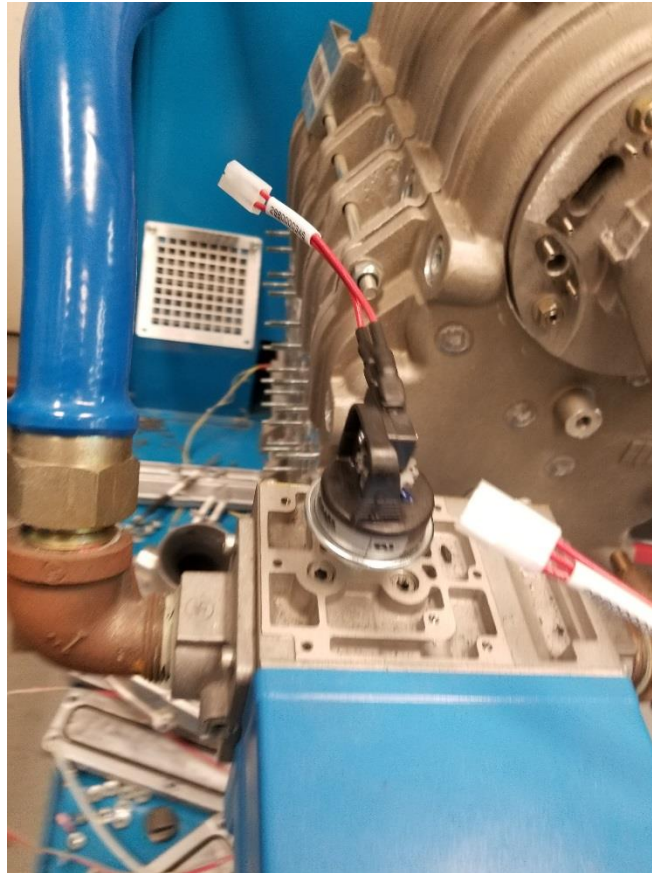

Figure 10



Patterson-Kelley
HARSCO

Instructions

NURO Conversion Instructions
MACH C750-C1050

1005101709
ENVI to NURO
Date: 12/21/2017
Revision A

- Using a deep socket loosen two 11/32" nuts on underside of front top crossbar. Once loosened, starting on left side, using a deep well socket take nut off and pull crossbar down. Put washer supplied onto stud located on cabinet above crossbar shown in figure 11. Tighten nut halfway onto stud and repeat with right side. Then tighten both nuts to secure crossbar fully.



Figure 11



Patterson-Kelley
HARSCO

Instructions

NURO Conversion Instructions
MACH C750-C1050

1005101709
ENVI to NURO
Date: 12/21/2017
Revision A

15. Using gasket tape supplied, tape the left side of the cabinet that does not have any shown in figure 12.

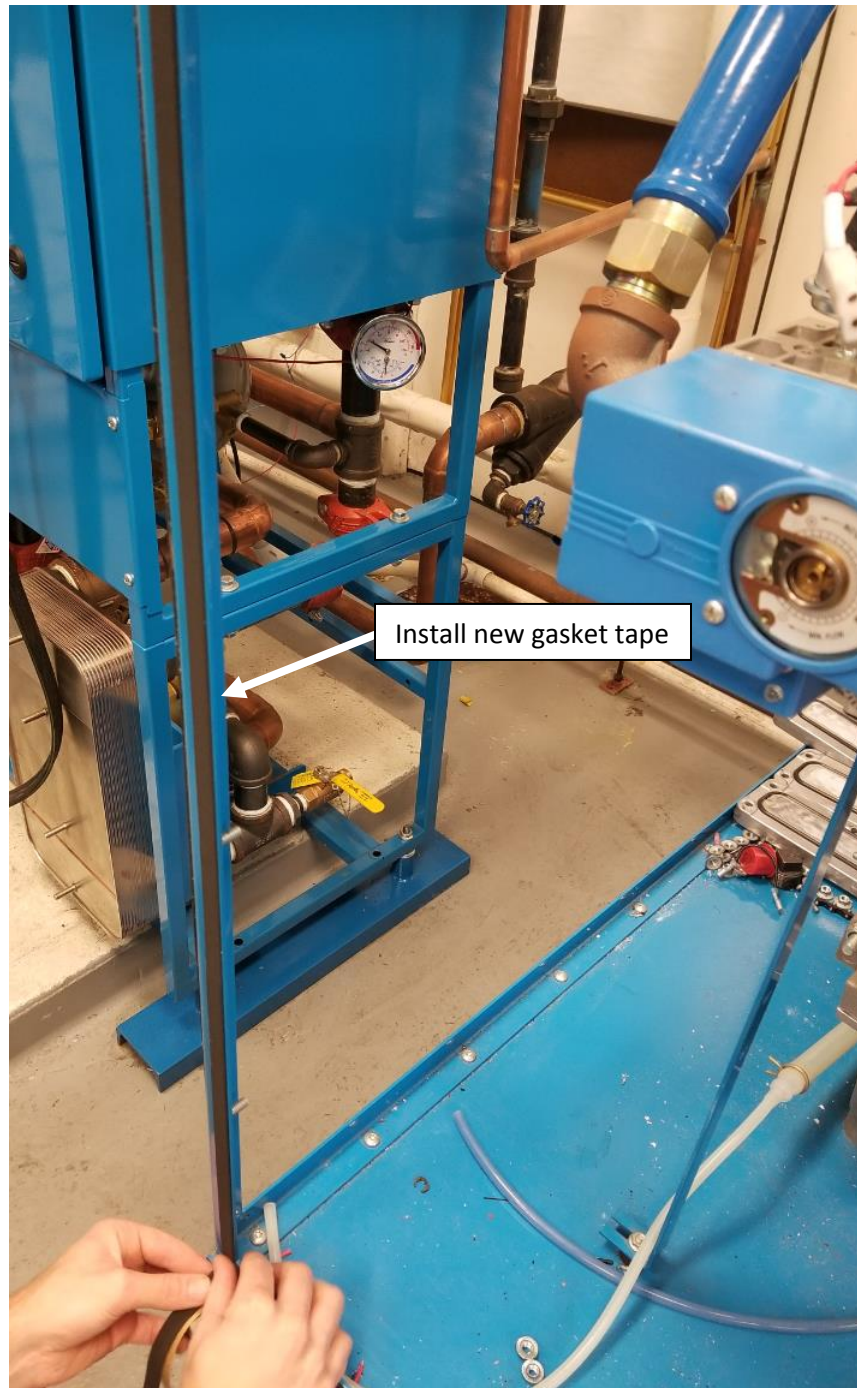

Figure 12



Patterson-Kelley
HARSCO

Instructions

NURO Conversion Instructions
MACH C750-C1050

1005101709

ENVI to NURO

Date: 12/21/2017

Revision A

16. Hang new front door on existing frame and center on top horizontal crossbar.
17. Using a 13/64" drill bit, drill 8 holes in the frame using the front door and holes as a guide.
18. Secure the front door with 8 1/4" Torx head screws shown in figure 13.



Figure 13



Patterson-Kelley
HARSCO

Instructions

NURO Conversion Instructions
MACH C750-C1050

1005101709

ENVI to NURO

Date: 12/21/2017

Revision A

19. Slide control panel onto 4 studs and secure with 4 nuts shown in figure 14.

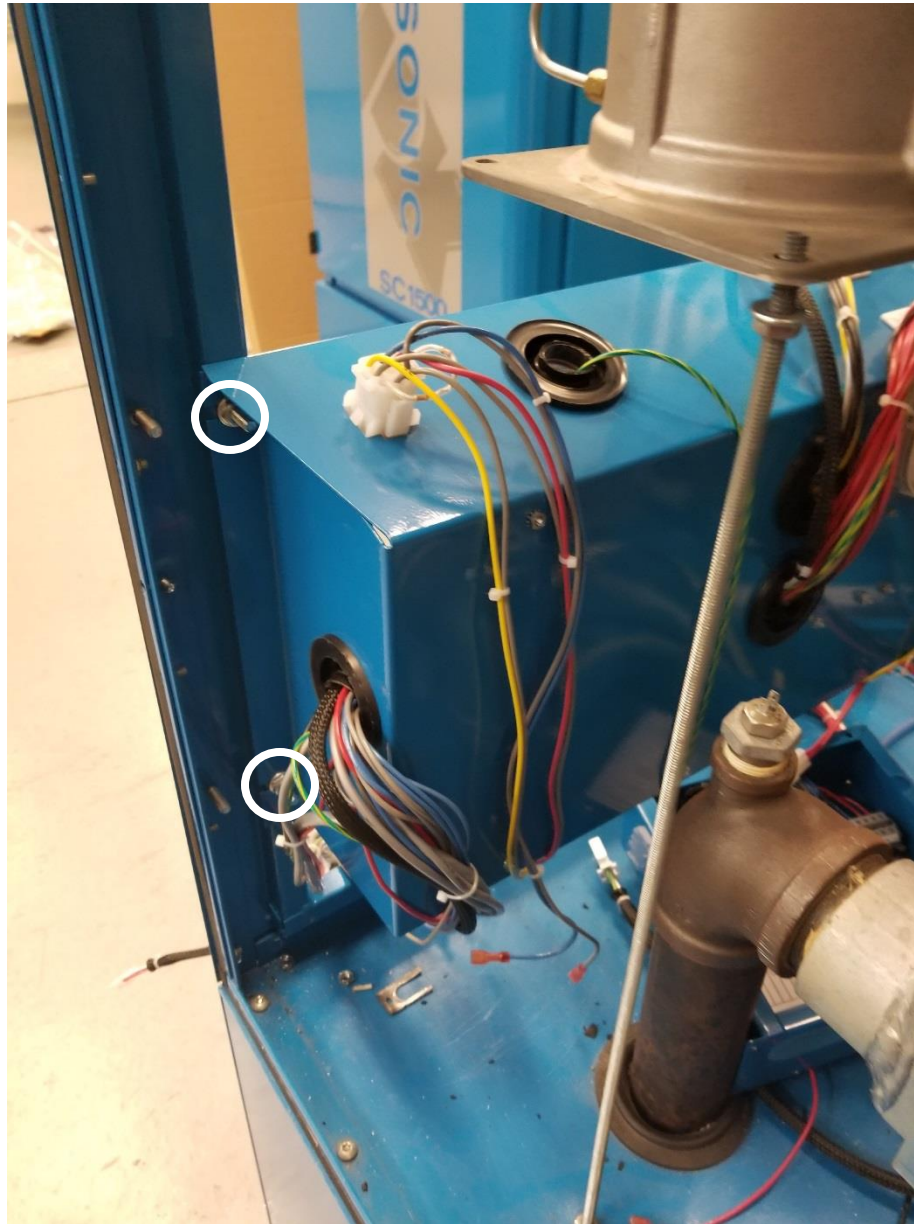

Figure 14



Patterson-Kelley
HARSCO

Instructions

NURO Conversion Instructions
MACH C750-C1050

1005101709
ENVI to NURO
Date: 12/21/2017
Revision A

20. Secure right-side terminal box by lining up right four screw holes and screw into place shown in figure 15.

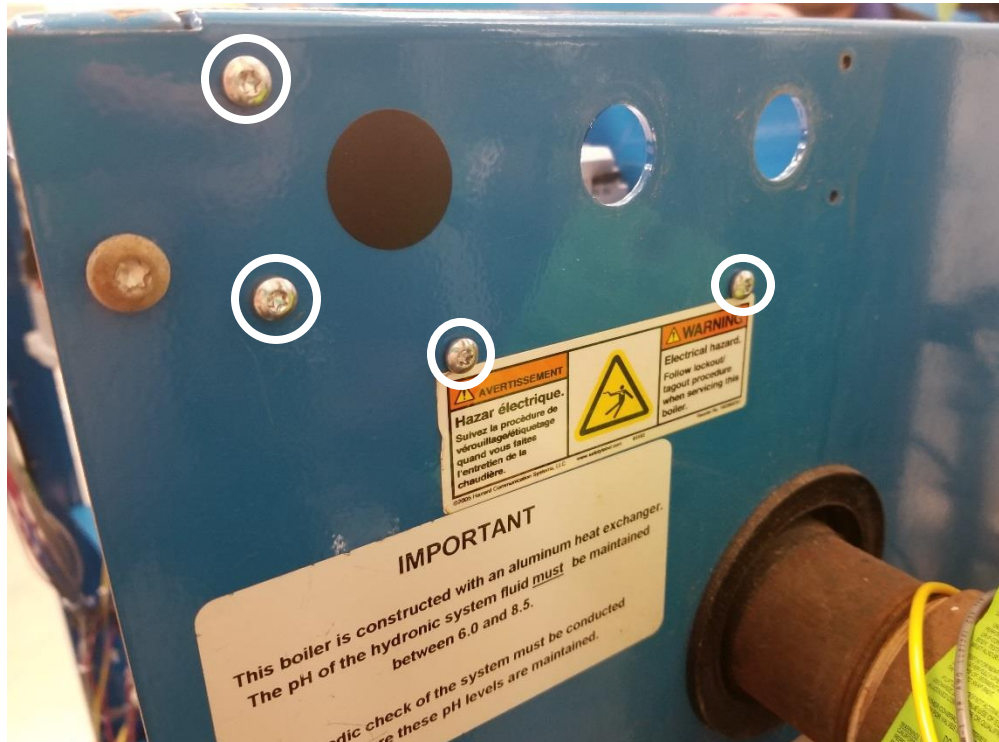

Figure 15

21. Repeat with left terminal box.
22. Run all internal wires to appropriate safety devices and sensors.

Types of Wires	Colors/Identification
Return Temperature Sensor Wires	Blue/Gray
Supply Temperature Sensor Wires	Red/Gray
Flue Temperature Sensor Wires	Yellow/Gray

Please refer to wiring diagram for any other connections. Ensure all wiring matches supplied wiring diagram.



Patterson-Kelley
HARSCO

Instructions

NURO Conversion Instructions
MACH C750-C1050

1005101709

ENVI to NURO

Date: 12/21/2017

Revision A

23. Using magnets and wire ties, the high voltage blower motor wire will be secured shown in figure 16 and plugged in as shown in figure 17.



Figure 16

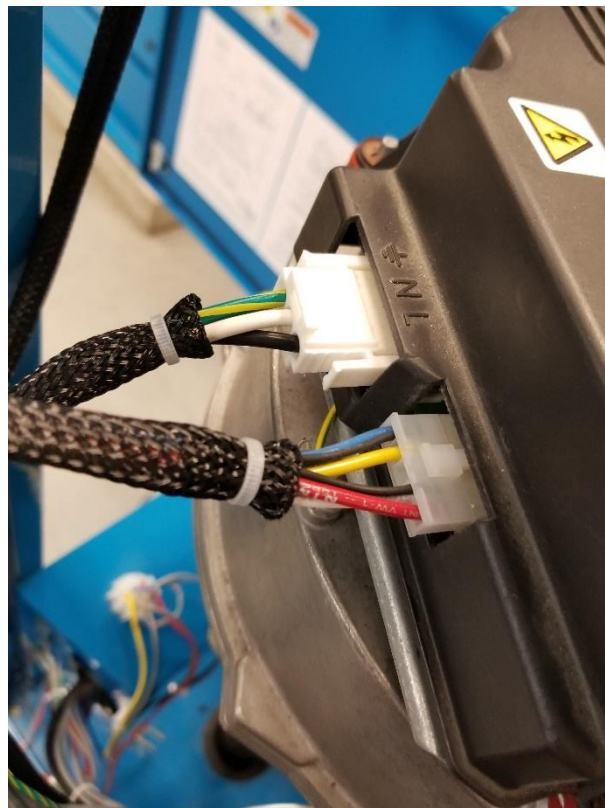

Figure 17



Patterson-Kelley
HARSCO

Instructions

NURO Conversion Instructions
MACH C750-C1050

1005101709
ENVI to NURO
Date: 12/21/2017
Revision A

24. Run igniter wire and ground to ignition electrode. Install gas valve plug with retaining screw shown in figure 18. High and low gas pressure switches will have matching electric connectors that will need to be plugged in.



Figure 18

25. Install tubing for air switch and blocked flue switch. Blocked flue tube will need to be cut to length to ensure that there is not tube slack. Tube should be pitched down from switch to condensate pan to ensure condensate will not accumulate in tube.

NOTE: Verify the orifice pieces are installed in the pressure switches.



Patterson-Kelley
HARSCO

Instructions

NURO Conversion Instructions
MACH C750-C1050

1005101709
ENVI to NURO
Date: 12/21/2017
Revision A

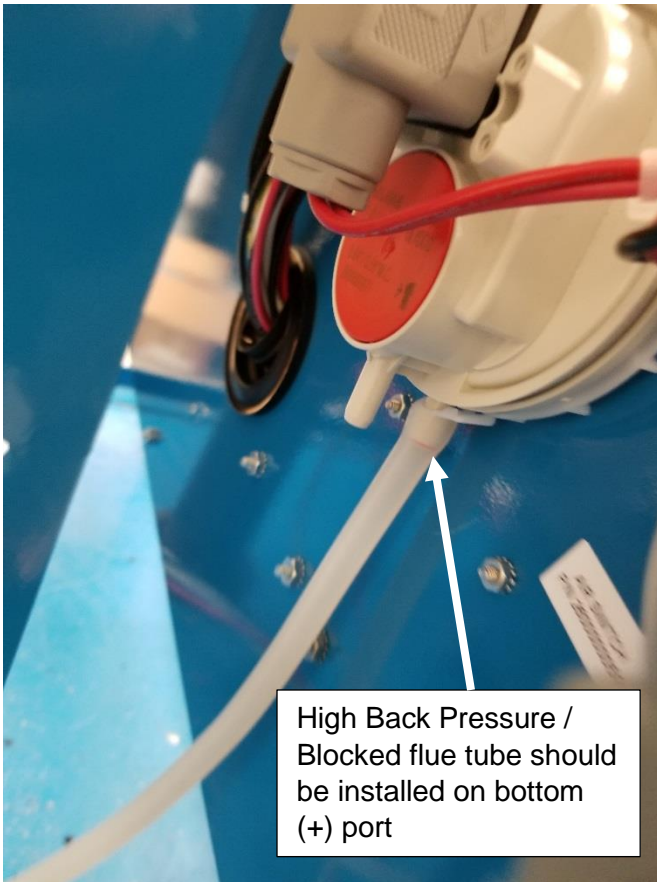

Figure 19

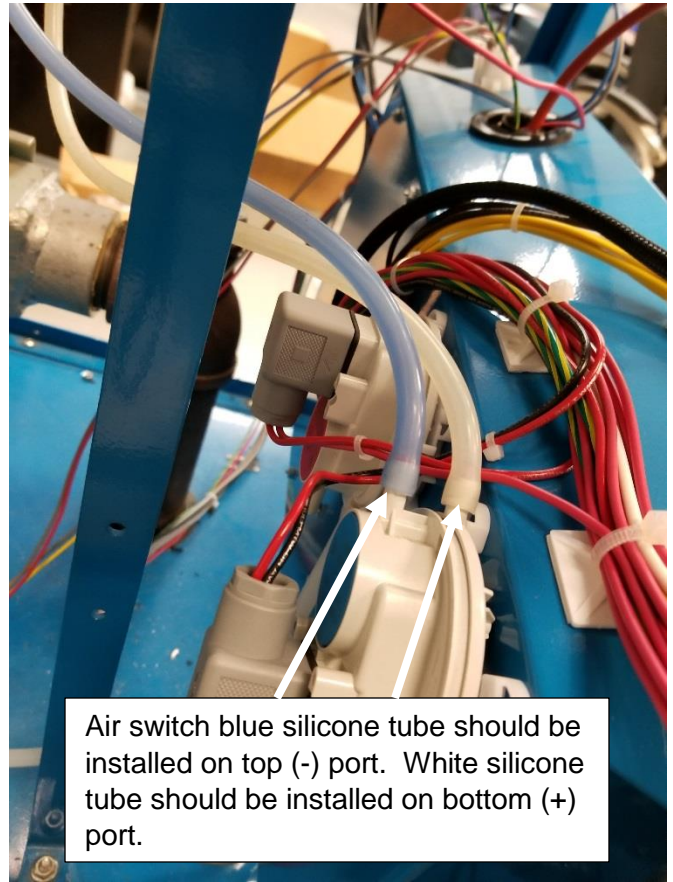

Figure 20

WARNING

Ensure the high back pressure tube continually slopes down from the switch to the condensate pan. If the tube "traps" moisture then the switch will not function properly.



Patterson-Kelley
HARSCO

Instructions

NURO Conversion Instructions
MACH C750-C1050

1005101709
ENVI to NURO
Date: 12/21/2017
Revision A

26. Install NURO touch screen assembly on door in order of nylon washer, NURO, nylon washer, nylon lock nut shown in figure 21.



Figure 21



Patterson-Kelley
HARSCO

Instructions

NURO Conversion Instructions
MACH C750-C1050

1005101709

ENVI to NURO

Date: 12/21/2017

Revision A

27. Insert green electric plug D1 and D2 into NURO control and attach all ground wires to front door ground lug.

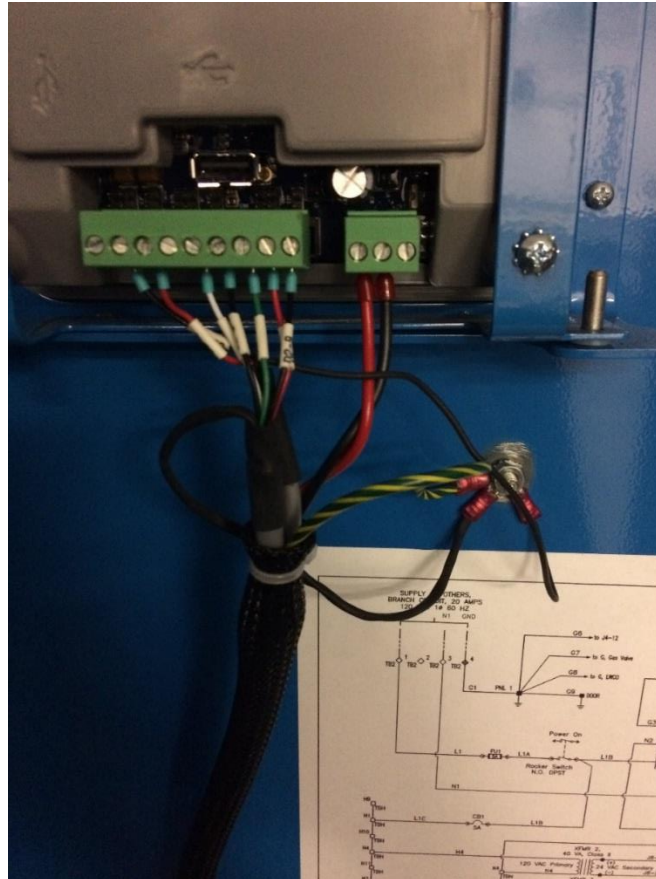

Figure 22

28. Install field wiring to new terminal boxes per wiring terminal block labels.
29. Install terminal box cover and secure with 4 Phillips head screws.



Patterson-Kelley
HARSCO

Instructions

NURO Conversion Instructions
MACH C750-C1050

1005101709
ENVI to NURO
Date: 12/21/2017
Revision A

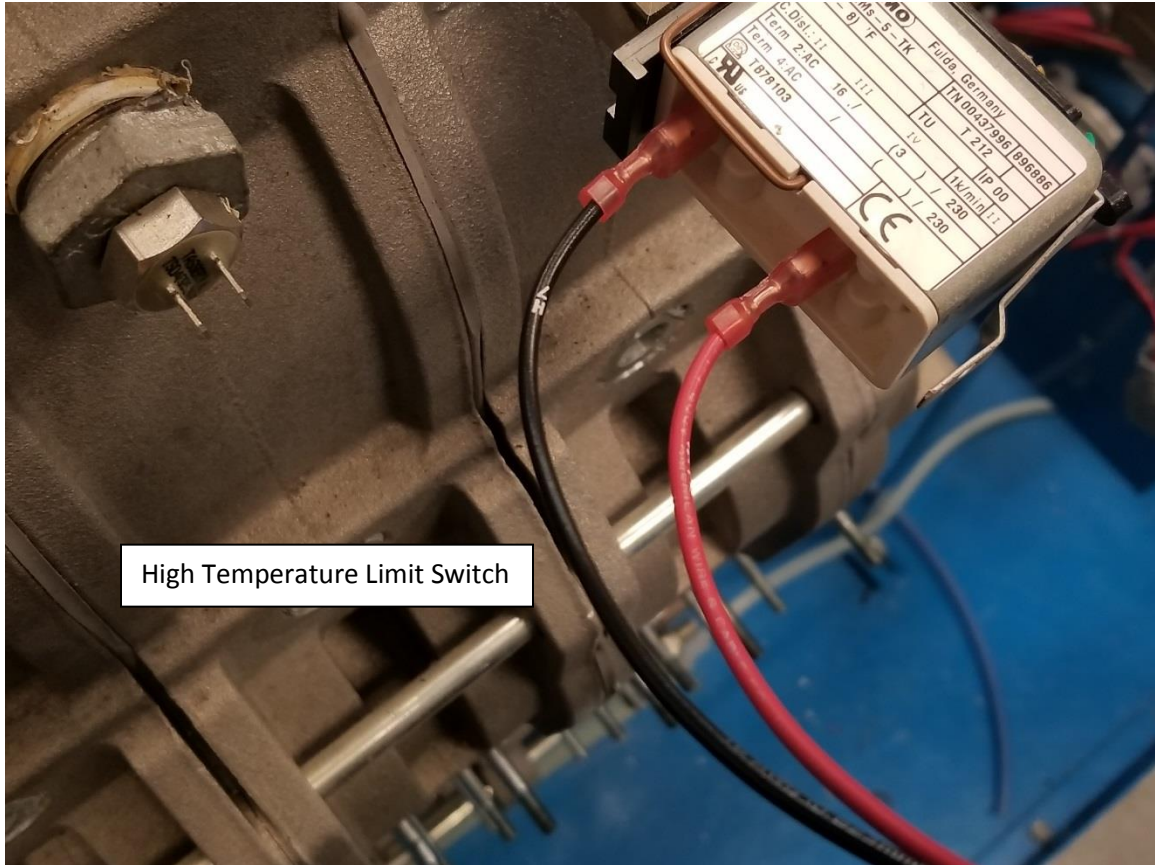

Figure 23



Patterson-Kelley
HARSCO

Instructions

NURO Conversion Instructions
MACH C750-C1050

1005101709
ENVI to NURO
Date: 12/21/2017
Revision A

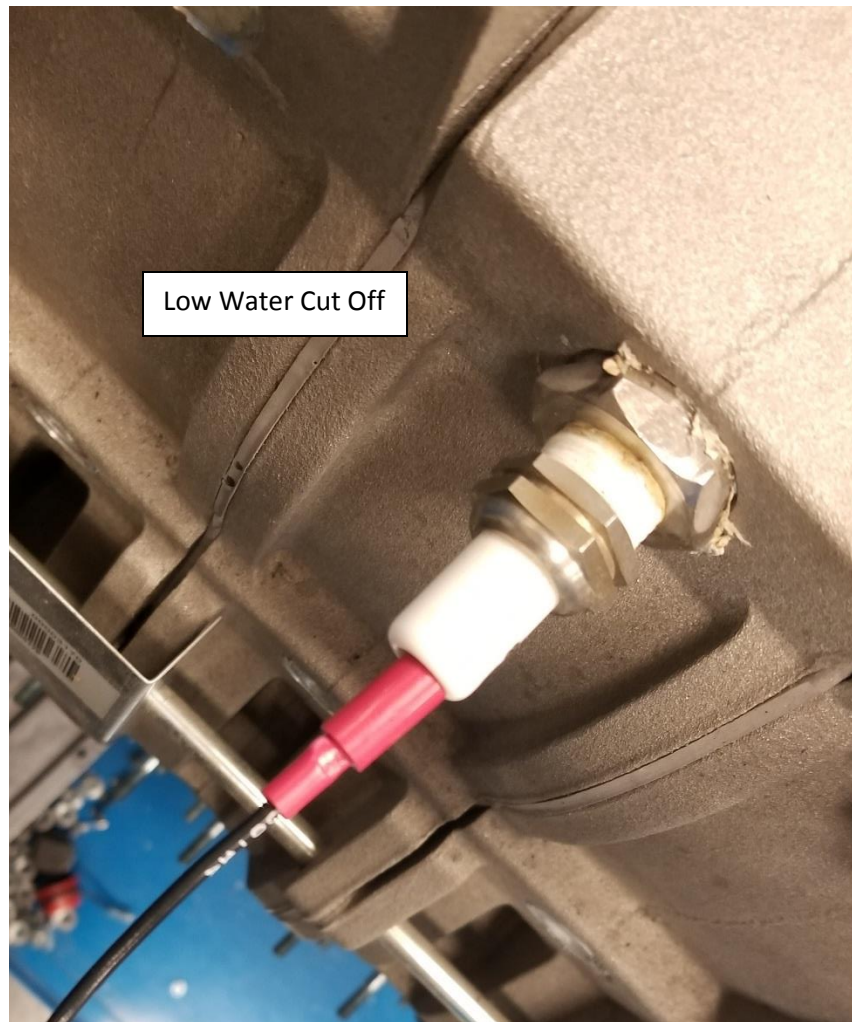

Figure 24



Patterson-Kelley
HARSCO

Instructions

NURO Conversion Instructions
MACH C750-C1050

1005101709

ENVI to NURO

Date: 12/21/2017

Revision A

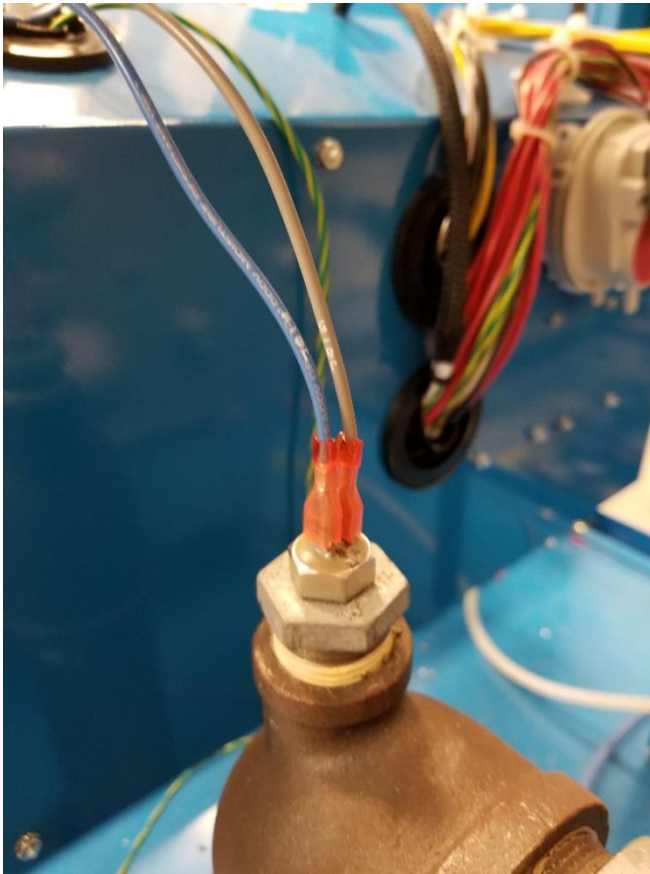

Figure 25

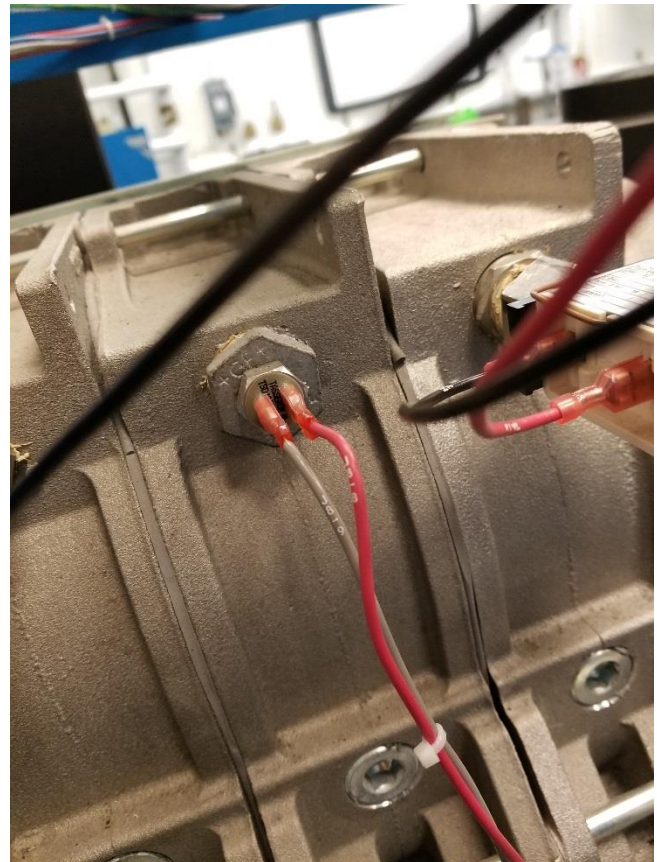

Figure 26

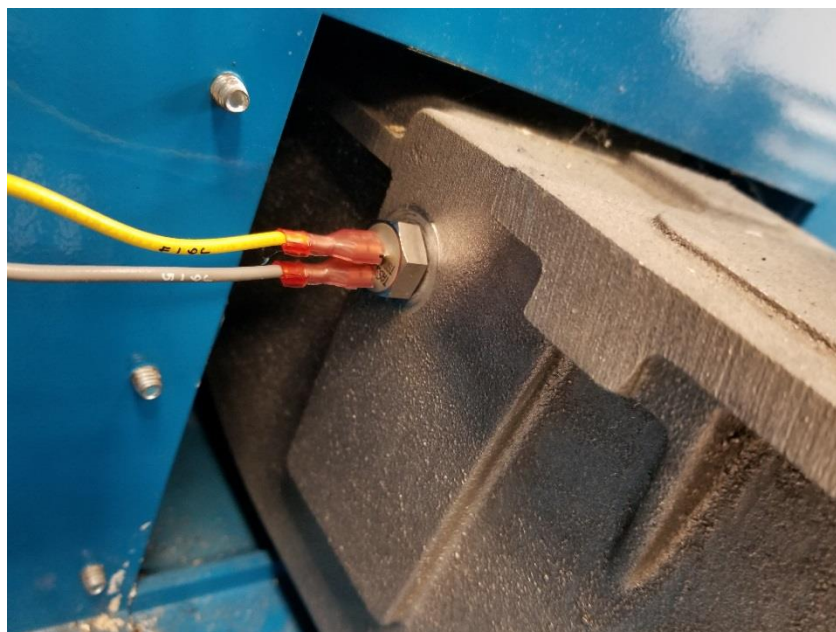

Figure 27



Patterson-Kelley
HARSCO

Instructions

NURO Conversion Instructions
MACH C750-C1050

1005101709
ENVI to NURO
Date: 12/21/2017
Revision A

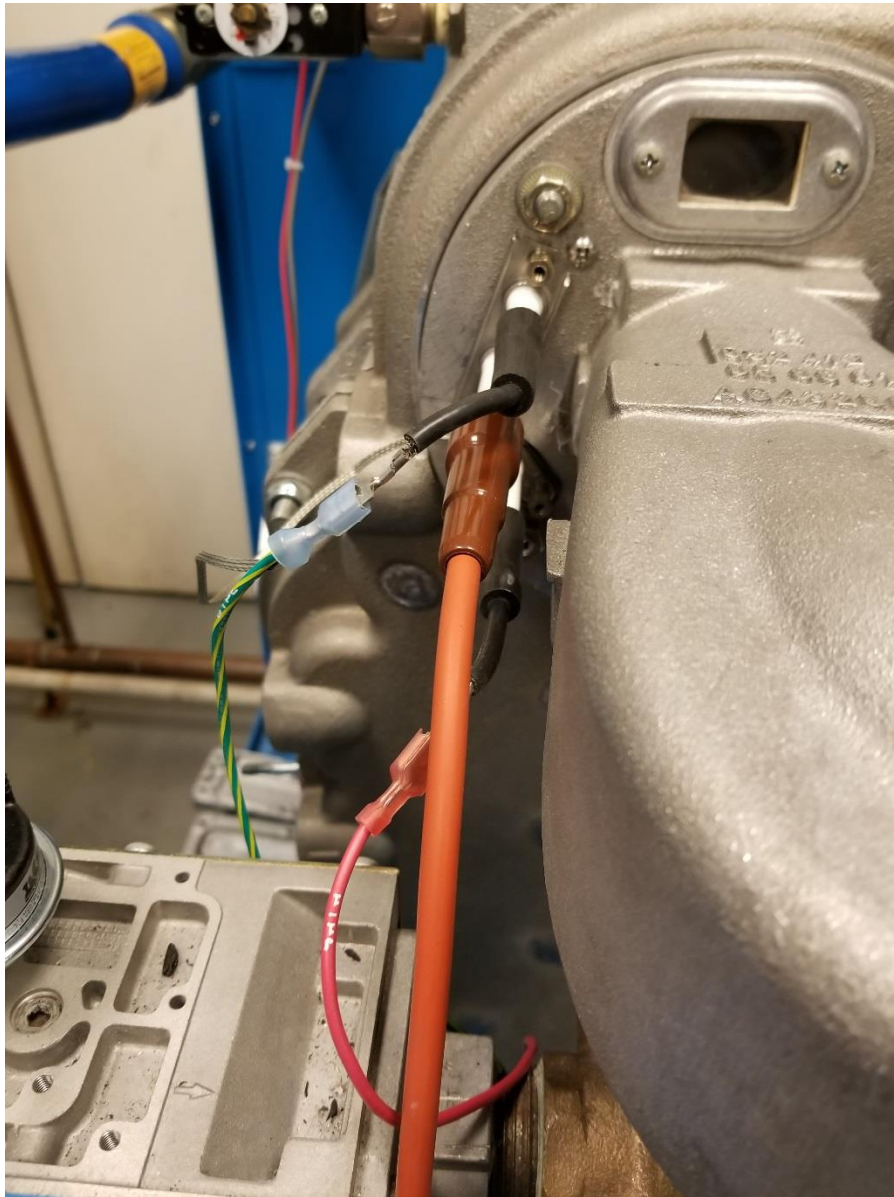

Figure 28



Patterson-Kelley
HARSCO

Instructions

NURO Conversion Instructions
MACH C750-C1050

1005101709

ENVI to NURO

Date: 12/21/2017

Revision A

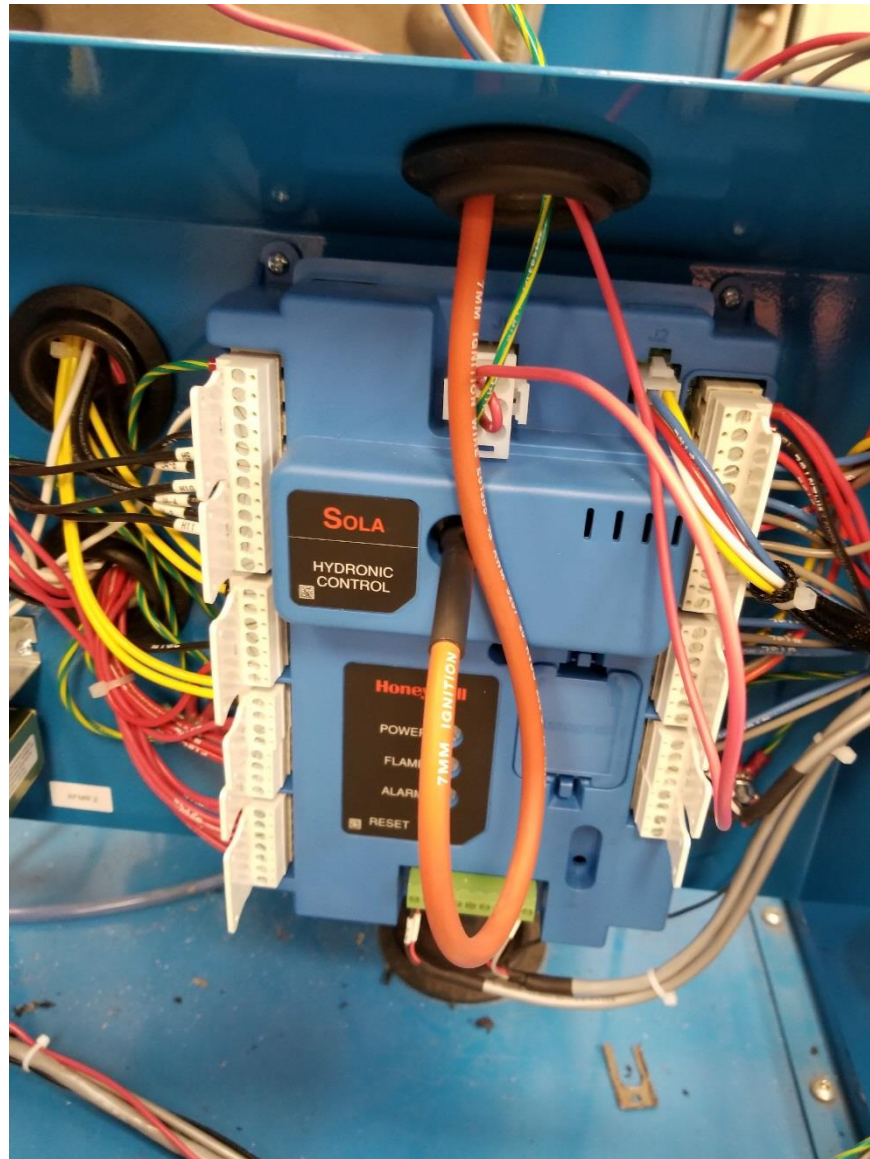

Figure 29

30. Re-energize power to unit. **DO NOT ENERGIZE GAS.** Call tech support for help pairing controls to boiler (570-421-7500 and press 2 for technical support).
31. After pairing is complete with technical support, re-energize gas supply to unit.
32. Perform Runout Procedure.
33. Perform factory start up and fill out start up report located in O&M manual and check all safety devices per O&M manual to ensure all are working properly.
34. Re-Install side and top panels of boiler.



Patterson-Kelley
HARSCO

Instructions

NURO Conversion Instructions
MACH C750-C1050

1005101709
ENVI to NURO
Date: 12/21/2017
Revision A

Runout Procedure

WARNING

Start Interlock 1, Start Interlock 2, and Air Damper terminals are 120 VAC. Power must be off when removing, installing jumpers, or wires to these terminals.

1. Remove the factory jumpers / field wiring from enable/disable, start interlock 1, start interlock 2, damper end switch terminals.
2. From the information screen on the NURO touch screen verify that the enable/disable circuit is open.
3. Reinstall the factory jumper or the field wiring in the enable/disable terminals and give the boiler a call for heat. Verify that the boiler is giving the error of start interlock 1 open.
4. Turn the boiler off and reinstall the factory jumper or field wiring into the start interlock 1 terminals.
5. Turn the boiler back on, reset the error and verify the boiler is going into a start interlock 2 open error.
6. Turn the boiler off and reinstall the jumper or field wiring in the start interlock 2 terminals.
7. Turn the boiler on, reset the error and allow the boiler to try and start. Verify that the boiler locks out on damper end switch did not close in allotted time.
8. Turn the boiler off and reinstall the factory jumper or damper end switch wires. Turn the boiler back on and reset the control.
9. In order to test the low water cut-out, press and hold the red "Push to Test" button for at least 5 seconds. A manual lockout reset error displaying 10010: "Low Water Limit" on the NURO touchscreen should occur. The red LED indicator on the Low Water cut-off will no longer be illuminated.
10. Optional Test Method: First turn the boiler off, and then turn off the boiler's circulating pump. Isolate the boiler from the system. Drain the water level below the low water cut-off probe. Turn the boiler back on. It should not operate, and a manual lockout reset error displaying 10010: "Low Water Limit" on the NURO touchscreen should occur. The red LED indicator on the Low Water cut-off will no longer be illuminated.
11. Return the system to normal operation by refilling with water, restarting the boiler's circulating pump, and then turning the boiler back on.
12. The boiler is furnished with a low gas pressure switch, installed near the boiler's main gas shutoff/control valve. The operation of this switch must be checked as follows:
 1. Close the main gas cock (external to the boiler).
 2. Cycle the boiler on by generating a heat request.
 3. Allow the boiler to proceed through prepurge and attempt ignition.

When the main gas shutoff/control valve opens to attempt ignition, the low gas pressure switch will trip, causing the NURO touchscreen to display 10012: "**Low Gas Limit**". Even after re-opening the main gas cock, 10012: "**Low Gas Limit**" will remain on the NURO display until the boiler is manually reset by pressing "Reset Control".

13. The boiler is furnished with a high gas pressure switch, installed near the boiler's main gas shutoff/control valve. The operation of this switch must be checked as follows:
 1. Before starting the boiler, close the downstream gas cock located inside the boiler's enclosure.
 2. Cycle the boiler on by generating a heat request.
 3. Allow the boiler to proceed through prepurge and attempt ignition.



Patterson-Kelley
HARSCO

Instructions

NURO Conversion Instructions
MACH C750-C1050

1005101709

ENVI to NURO

Date: 12/21/2017

Revision A

When the main gas shutoff/control valve opens to attempt ignition, the high gas pressure switch will trip, causing the NURO touchscreen to display 10011: **“High Gas Limit”**. Even after re-opening the downstream gas cock inside the boiler, 10011: **“High Gas Limit”** will remain on the NURO display until the boiler is manually reset by pressing **“Reset Control”**.

14. Test the ignition system safety shutdown as follows:
 1. Cycle the boiler on by generating a heat request. (The method for this will depend on your boiler configuration.)
 2. During the pre-purge cycle (before ignition), smoothly close the downstream manual isolation valve (inside the boiler cabinet) to reduce the gas flow.
 3. Closing the manual isolation valve will prevent a successful ignition, and the NURO will display either:
 - 109: **“Ignition Failed”**
 - 110: **“Ignition Failure Occurred”**These alarms indicate an ignition failure and the lockout will remain until the control is reset. After completing this test, turn the boiler off, open the downstream manual isolation valve, then turn the boiler back on and reset the control.
15. Test the air switch for proper operation. Allow the boiler to start. Remove the tube from the air switch, after 30 seconds the control should lock out on air switch not closed. reinstall the tube and reset the boilers control.
16. Testing the blocked flue switch. Allow the boiler to start, remove the blocked flue tube from the condensate pan and apply a positive pressure to the tube. Verify that the boiler locked out on a blocked flue error. Reinstall the blocked flue tube and reset the control.
17. To test the supply, return, flue, and heat exchanger temp sensors you will need to disconnect one wire from each sensor. Verify that the boiler goes into a blocking error for each correct sensor.
18. To test the high limit, allow the boiler to start, then turn the high limit down slowly and verify that the boiler locks out on high limit. the high limit should be at the same temperature as the supply water temperature at the time that it trips. Turn the high limit all the way up, reset the limit and reset the boilers control.
19. In order to test the operating limit on the boiler, verify that the boiler turns on below the setpoint minus the differential, and shuts down at the setpoint plus the off differential.



Patterson-Kelley
HARSCO

Instructions

NURO Conversion Instructions
MACH C750-C1050

1005101709
ENVI to NURO
Date: 12/21/2017
Revision A



**P-K BOILER
START-UP REPORT**

Date: _____

Boiler Serial # _____ Model # _____

Installation: Name: _____ City: _____

State: _____ Zip: _____ Contact: _____ Phone: _____

Installer Name: _____ Type of Installation: _____ (Hotel, School, etc.)

Fuel: Natural Gas _____ Propane _____

Outdoor Temperature Sensor Connected Yes: _____ No: _____

Field Fire-Test	High	Low	DATE:
Inlet Gas	_____ "w.c.	_____ "w.c.	
Oxygen (O2)	_____ %	_____ %	
Carbon Dioxide (CO2)	_____ %	_____ %	
Carbon Monoxide (CO)	_____ ppm	_____ ppm	
Nox	_____ ppm	_____ ppm	
Gross Stack Temp.	_____ ° F	_____ ° F	
Combustion Air Temp.	_____ ° F	_____ ° F	
Stack Press.(exhaust)	_____ "w.c.	_____ "w.c.	
Main Flame Signal	_____ Volts or uA	_____ Volts or uA	
Efficiency	_____ %	_____ %	
Comb. Air Pres. (Intake)	_____ "w.c.	_____ "w.c.	

Lockup/Static Gas pressure

Gas pressure drop @ ignition _____

- Water Inlet temperature: _____ ° F
- Water Outlet temperature: _____ ° F
- Flow through boiler: _____ GPM
- Operating Temperature Setpoint: _____ ° F (from Internal OR external control)
- Approximate stack length: _____ Ft. Horizontal _____ Ft. Vertical _____ Flue Pipe Diameter
- Incoming Electrical Power _____ Volts a.c. Less than 1 volt between neutral and ground
- System Water pH level _____
- Comments:

Performed by PK
Certified Agent: _____
(Print Name)

Start Up Certification # _____



Patterson-Kelley
HARSCO

Instructions

NURO Conversion Instructions MACH C750-C1050

1005101709

ENVI to NURO

Date: 12/21/2017

Revision A

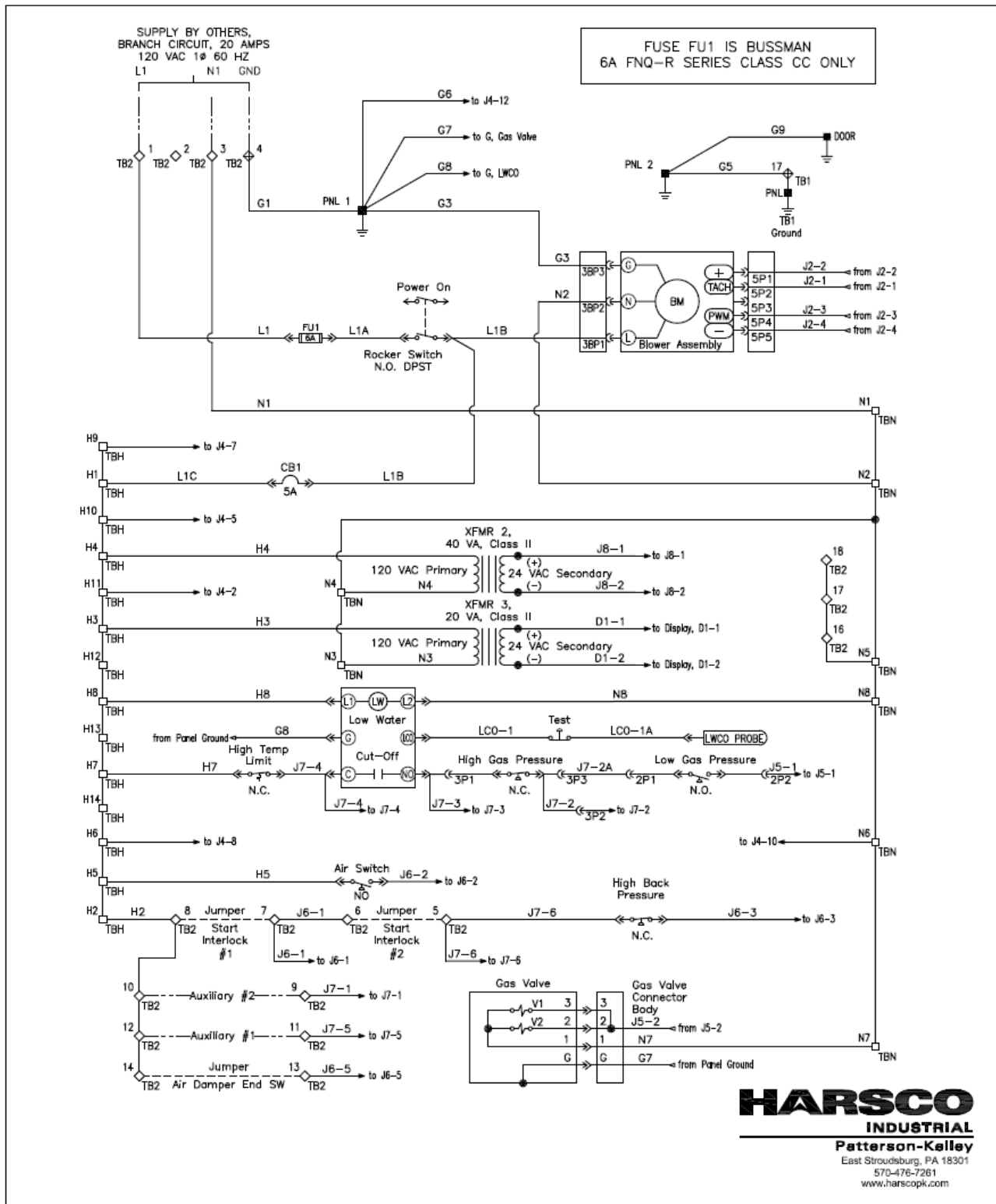

IF ANY OF THE ORIGINAL WIRE SUPPLIED WITH THIS BOILER MUST BE REPLACED, IT MUST BE REPLACED WITH THE SAME UL WIRE TYPE.

**C750-C900-C1050 / 120 VOLT
NURO® Control (Conversion)**

262100056 (1)
REV. B



Patterson-Kelley
HARSCO

Instructions

NURO Conversion Instructions MACH C750-C1050

1005101709

ENVI to NURO

Date: 12/21/2017

Revision A

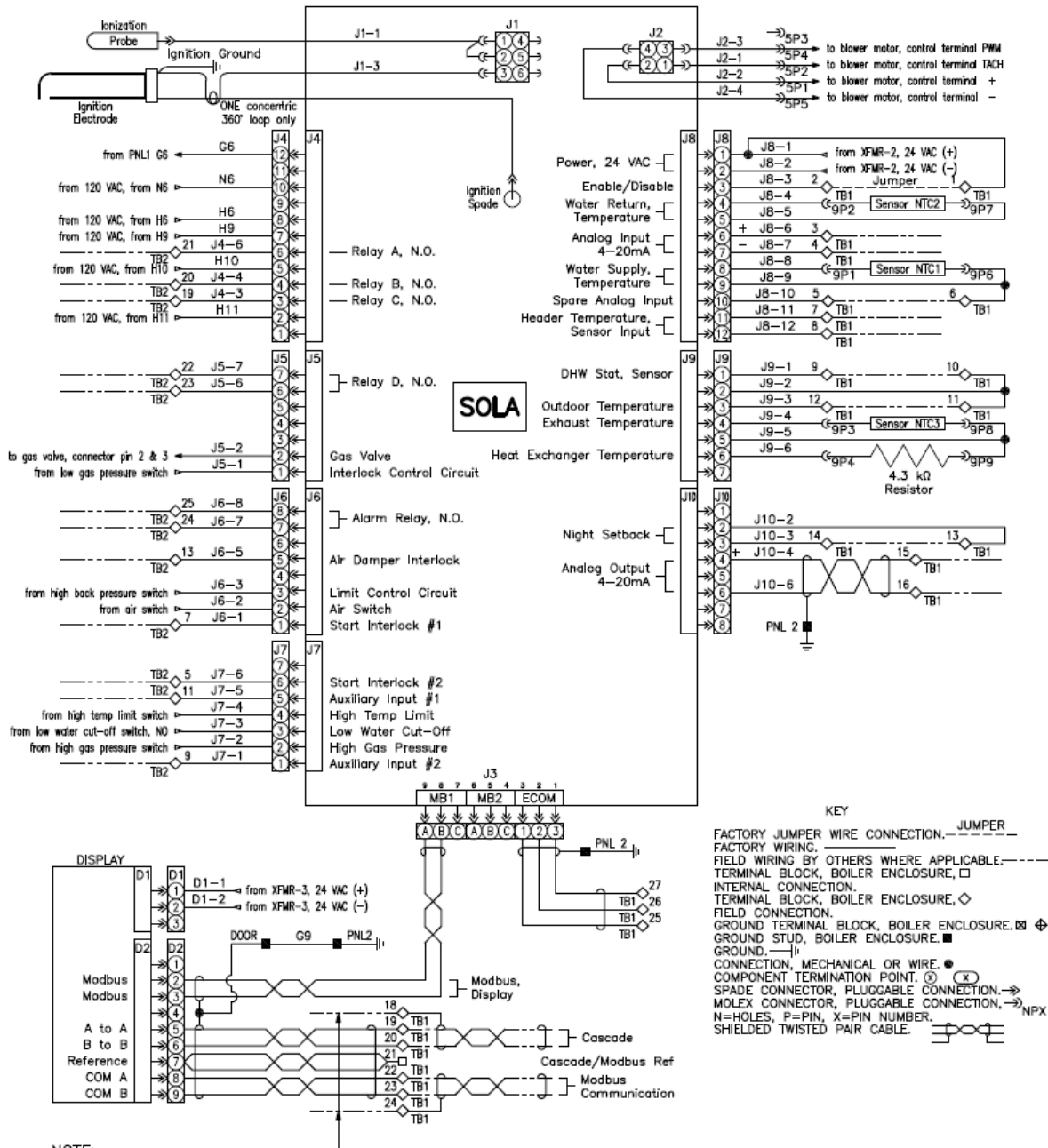

NOTE:
Modbus and or Cascade field wiring must utilize twisted pair shielded cable. For multi boiler installations, JUMPER the field Modbus and or Cascade shield connection "TB1-18 and or TB1-24" to PNL ground in Master boiler TB1 terminal box. Do not ground shield to any other boiler or piece of equipment. Shield should be continuous from beginning to end with a ground connection in the master boiler only.

HARSCO
INDUSTRIAL
Patterson-Kelley
East Stroudsburg, PA 18301
570-476-7261
www.harscopk.com

IF ANY OF THE ORIGINAL WIRE SUPPLIED WITH THIS BOILER MUST BE REPLACED, IT MUST BE REPLACED WITH THE SAME UL WIRE TYPE.

**C750-C900-C1050 / 120 VOLT
NURO® Control (Conversion)**

2621000056 (2)
REV. B