

MVF461H Series

Modulating Control Valves with Magnetic Actuators, Positioning Control and Position Feedback for Hot Water and Steam

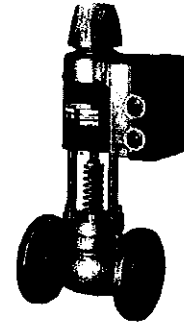







Description	Control valves with magnetic actuators, for modulating control of hot water, high temperature hot water, and steam.						
Features	<ul style="list-style-type: none"> • Fast positioning time (< 2 seconds) • Selectable valve characteristic: Equal percentage or linear • Selectable standard interface: 0/2 to 10 Vdc or 0/4 to 20 mA • High resolution (>1:1000) • High rangeability • Wear-free inductive stroke measurement • Spring return A → AB closed when de-energized • Positioning control and position feedback signal • Low-friction, heavy-duty and maintenance-free • Phase-cut signal input for Staefa controllers 						
Product Numbers	See Table 1.						
Warning/Caution Notations	<table border="1" style="width: 100%; border-collapse: collapse;"> <tr> <td style="width: 20%;">WARNING:</td> <td style="width: 15%; text-align: center;"></td> <td>Personal injury or loss of life may occur if you do not follow the procedures as specified.</td> </tr> <tr> <td>CAUTION:</td> <td style="text-align: center;"></td> <td>Equipment damage or loss of data may occur if you do not follow the procedures as specified.</td> </tr> </table>	WARNING:		Personal injury or loss of life may occur if you do not follow the procedures as specified.	CAUTION:		Equipment damage or loss of data may occur if you do not follow the procedures as specified.
WARNING:		Personal injury or loss of life may occur if you do not follow the procedures as specified.					
CAUTION:		Equipment damage or loss of data may occur if you do not follow the procedures as specified.					
Application	<p>The MVF461H Series valves are through-port or mixing valves with magnetic actuators. The actuator is equipped with an electronics module for positioning control and position feedback. If the power is off, the valve control path A → AB is closed.</p> <p>The short positioning time, high resolution and high rangeability make these valves ideal for proportional control of district heating stations, and heating applications using high temperature hot water and steam.</p>						

Table 1. Product Numbers.

Product Number	Line Size (in)	Cv	Δp_s (psi)	Δp_{vmax} (psi)	S_{NA} (VA)	P _{med} (W)	I _N Fuse	Wire Gauge (AWG)		
								16	14 L (ft)	12
MVF461H15-0.6	1/2	0.7	145	145	33	15	3.15	130	215	360
MVF461H15-1.5	1/2	1.8	145	145	33	15	3.15	130	215	360
MVF461H15-3	1/2	3.5	145	145	33	15	3.15	130	215	360
MVF461H20-5	3/4	5.9	145	145	33	15	3.15	130	215	360
MVF461H25-8	1	9.4	145	145	33	15	3.15	130	215	360
MVF461H32-12	1-1/4	14.0	145	145	43	20	4	100	165	260
MVF461H40-20	1-1/2	23.3	145	145	65	20	6.3	100	165	260
MVF461H50-30	2	35.0	145	145	65	26	6.3	65	100	165

Key:

- Δp_{vmax} = Maximum permissible differential pressure across the valve's control path, valid for the entire actuating range of the motorized valve (maximum recommended operating differential pressure).
- Δp_s = Maximum permissible differential pressure at which the motorized valve will close securely against the pressure (close-off pressure).
- S_{NA} = Nominal apparent power for selecting the transformer.
- P_{med} = Average true power.
- I_N = Slow fuse (mandatory).
- Cv = Nominal flow rate of cold water [41°F to 86°F (5°C to 30°C)].
- L = Maximum cable length. With four-wire connections the maximum permissible length of the separate 14 AWG Cu signal cable is 656 feet (200 m).

Ordering

The valve body and magnetic actuator assemblies cannot be separated. The assemblies can also be ordered with NPT flanges or weld flanges. To order with NPT flanges, add an "-N" suffix to the part number. To order with Weld Flanges, add a "-W" suffix to the part number. When placing an order, specify the quantity, product number and description.

- Examples:** (without flanges) 1 MVF461H15-0.6 valve
 (with NPT flanges) 1 MVF461H15-0.6-N valve with NPT flanges
 (with weld flanges) 1 MVF461H15-0.6-W valve with weld flanges

Accessory

ASE12 Replacement Circuit Board

**Technical/
 Mechanical Design**

The electronics module converts the positioning signal to a phase-cut power signal, which generates a magnetic field in the coil. This causes the armature to change its position according to the interacting forces (magnetic field, counterspring, hydraulics, etc.). The armature responds rapidly to any change in signal, transferring the corresponding movement directly to the valve plug. This enables fast changes in load to be corrected quickly and accurately.

Automatic Control

The valve's position is measured continuously. Any disturbance in the system is rapidly corrected by the internal positioning controller, which ensures that the positioning signal and the valve stroke are exactly proportional, and also delivers the position feedback signal.

Control

The magnetic actuator can be driven by any controller with a 0/2 to 10 Vdc or 0/4 to 20 mA output signal.

To achieve optimum control performance, using a 4-wire connection for the valve is recommended.

The controller's signal ground terminal M must be connected to the valve's terminal M. Terminals M and G0 have the same potential and are internally interconnected in the valve's electronics.



CAUTION:

You must use a four-wire connection with Vdc power supply.

Basic Diagram

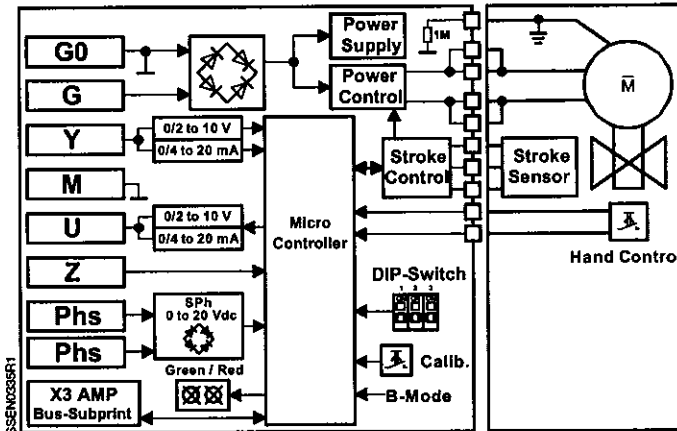

Spring Return Action

If the power or positioning signal is switched off or fails, the valve control path (port A → AB) is automatically closed by the force of the spring.

Table 2. Indication of Operating State.

LED	Indication	Operating State, Function	Remarks, Troubleshooting
Green	Lit	Control mode	Normal operation; everything is OK.
	Flashing	Calibration	Wait until calibration is finished (green or red LED will be lit).
		In manual control	Hand wheel in Man or Off position.
Red	Lit	Calibration error	Recalibrate (bridge contacts behind the calibration slot).
		Internal error	Replace electronics module.
	Flashing	Main fault	Check electric main network (outside the frequency or voltage range);
Both	Dark	DC Supply +/-	Vdc supply +/- connection polarity.
		No power supply	Check electric main network, check wiring
		Electronics faulty	Replace electronics module.

Manual adjustment

Press (a) and turn the hand wheel (b):

- clockwise (CW). Control path A → AB can be mechanically opened to between 80% and 90%, or
- counterclockwise (CCW). The actuator will be switched off and the valve closed.

As soon as the hand wheel is pressed and turned, neither the forced control signal Z, the input signal Y, nor the phase-cut signal acts on the actuator. The green LED will flash.

For automatic control, the hand wheel must be set to the Auto position. The green LED will be lit.

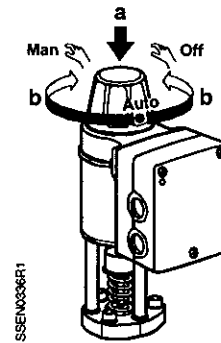

Figure 1.

Calibration

If the electronics module is replaced or the actuator turned through 180°, the valve's electronics must be recalibrated. To recalibrate, the hand wheel must be set to Auto.

The printed circuit board has a slot (see Figure 2). Calibrate by bridging the contacts located behind the slot on the printed circuit board, using a screwdriver. The valve will then travel across the full stroke to store the end positions.

While calibration is in progress, the green LED will flash for about 10 seconds (see Table 2. Indication of Operating State).

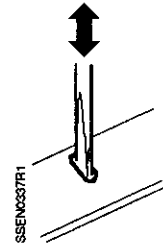

Figure 2.

DIP Switches

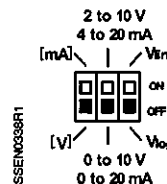





Figure 3. Configuration DIP Switches.

DIP	Function	OFF (Default)	ON	Remarks
1 	Voltage or current input	[V]	[mA]	Assignment of terminal Y: Voltage or current
2 	Correcting span Terminals Y and U	0 to 10 Vdc, 0 to 20 mA	2 to 10 Vdc, 4 to 20 mA	Offset settings of input and output
3 	Characteristic	V _{log} (equal percentage)	V _{lin} (linear)	

DIP Switches, Continued

SSEN0339R1			
		0 to 10 V	2 to 10 V
		0 to 20 mA	4 to 20 mA

Figure 4. Assignment of Positioning Signal Y: Voltage or Current.

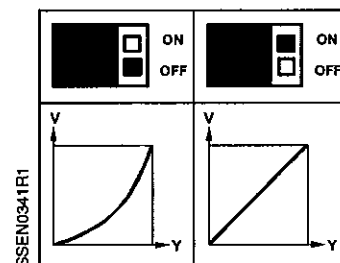

Figure 5. Selection of Valve Characteristic: Equal-Percentage or Linear.

SSEN0340R1			
	$R_l > 500 \Omega$	0 to 10 V	2 to 10 V
	$R_l < 500 \Omega$	0 to 20 mA	4 to 20 mA

Output signal U (position feedback signal) is dependent on the load resistance. Above 500 ohm, it is automatically a voltage signal; below 500 ohm a current signal.

Figure 6. Assignment of Correct Span Y and U: 0 to 10 Vdc/0 to 20 mA or 2 to 10 Vdc/4 to 20 mA.

Forced Control Input

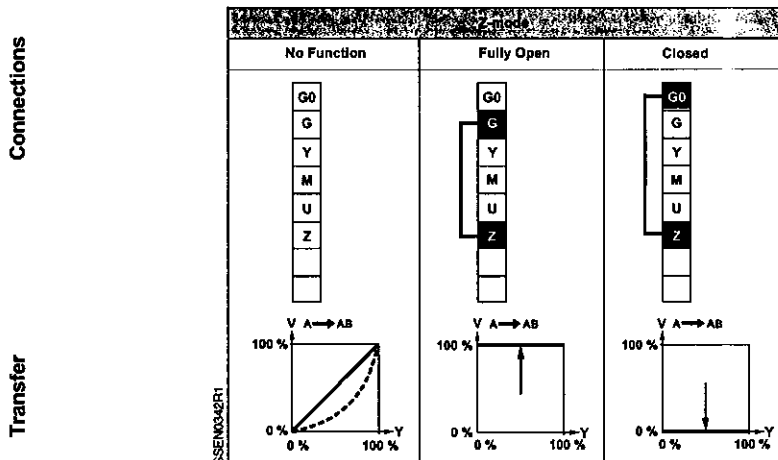

Figure 7.

If terminal Z for the forced control input is:

- not connected, the valve will follow the Y-signal or the phase-cut signal.
- connected to G, the valve will fully open via control path A → AB.
- connected to G0, the valve will close via control path A → AB.

Signal Priority

1. Hand wheel position Man or Off
2. Forced control signal Z
3. Phase-cut signal
4. Signal input Y

Characteristic

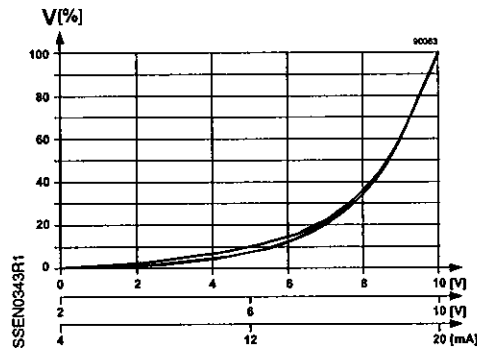

Figure 8. Equal Percentage.

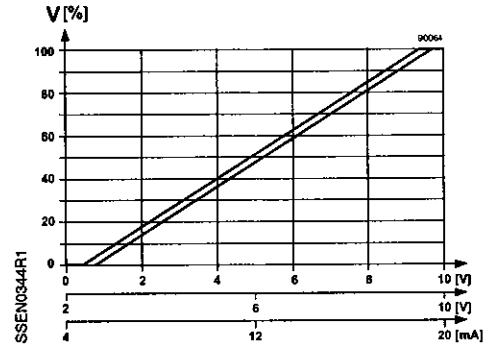

Figure 9. Linear.

Installation Notes

- Installation instructions for the valve and terminal housing are enclosed with the valve.
- For electrical installation, see *Wiring Diagrams*.



CAUTION:

- Always disconnect the power before fitting or removing the terminal housing. The terminal housing is calibrated and matched to the actuator, and should be replaced only by qualified personnel.
- Valve may only be used in flow direction (A → AB). Note the flow direction.
- Do not allow the surface temperature of the actuator to fall below the dew point temperature of the surrounding air (causing condensation). If necessary, insulate the valve. **Do not** insulate the actuator.

Mounting Position

Vertical to horizontal mounting:
 Do not mount the valve below horizontal.

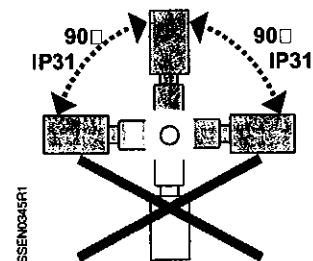

Figure 10. Acceptable Mounting Positions.

Specifications

Electrical

Low-voltage use only	Class 2 (SELV, PELV)
24 Vac	
Operating voltage	24 Vac +20/-15%
Frequency	45 to 65 Hz
Typical power consumption	See Table 1, P _{med}
Standby	<1 W (valve fully closed)
Nominal apparent power	See Table 1, S _{NA}
Suitable fuse	Slow, see Table 1, I _N
24 Vdc	
Operating voltage	20 to 30 Vdc

Specifications, Continued		
Functional data of actuator	Input	
	Positioning signal Y	0/2 to 10 Vdc, 0/4 to 20 mA, or 0 to 20 Vdc Phs
	Impedance	0/2 to 10 Vdc 0/4 to 20 mA
	100K ohm//5nF	
	240 ohm//5nF	
	Forced control	
	Impedance	22K ohm
	Closing the valve (Z connected to G0)	<1 Vac; <0.8 Vdc
	Opening the valve (Z connected to G0)	>6 Vac; >5 Vdc
	No function (Z not wired)	Phase-cut or positioning signal Y active
Functional data of valve	Output	
	Position feedback signal voltage	0/2 to 10 Vdc; load resistance > 500Ω
	current	0/4 to 20 mA; load resistance ≤ 500Ω
	Stroke measurement	Inductive
Nonlinearity	±3% of end value	
Functional data of valve	Nominal pressure	ANSI 125 (PN 16)
	Permissible Operating pressure ¹⁾	
	Water up to 248°F (120°C):	232 psi (16 bar)
	Water above 248°F (120°C):	188 psi (13 bar)
	Saturated steam:	130 psi (9 bar)
	Pressure differential $\Delta p_{max}/\Delta p_S$	145 psi (10 bar)
	Leakage at $\Delta p = 0.1$ MPa (1 bar)	A → AB Maximum 0.05% C _V
	Media temperature	34°F to 356°F (>1°C to 180°C)
	Valve characteristic ²⁾	Equal percentage or linear, optimized near the closing point
	Resolution $\Delta H/H_{100}$	1:1000 (H = Stroke)
Type of operation	Modulating	
Position when de-energized	A → AB closed	
Orientation:		Upright to horizontal
	Positioning time	< 2 seconds
Materials	Valve body	Modular cast iron
	Cover flange	Modular cast iron
	Seat/Inner valve	Stainless Steel
	Valve stem seal	EPDM (O-ring)
Electrical connections	Cable entries	3 × M20 × 1.5 or PG13.5/G1/2
	Connection terminals	Screw terminals for up to 12 AWG wires
	Min. cross-sectional area ³⁾	0.75 mm ²
	Max. cable length	See Table 1
Ambient conditions	Temperature	
	Operation and storage	23°F to 113°F (-5°C to 45°C)
	Transport	-13°F to 158°F (-25°C to 70°C)
Humidity	5 to 95% rh (non-condensing)	

1. Tested at 1.5 × PN (24 bar), similar to DIN 3230-3.

2. Can be selected via DIP switch.

3. In case of strong vibrations, use high-flex stranded wires.

**Specifications,
 Continued**

Agency approvals

Degree of protection

IP31 to IEC 529
 Conforms to CE requirements
 UL 873
 Certified to Canadian standard C22.2
 No. 24
 C-Tick N-474
 PED 97/23/EC:
 pressure-carrying parts
 Par. 1, section. 2.1.4/Par. 3, section 3
 Fluid group 2

Miscellaneous

Weight
 Dimensions

See Figure 15
 See Figure 15

**Connection
 Terminals**



WARNING:

If the controller and the valve receive their power supply from separate sources, the valve transformer must not be grounded on the secondary side.

A four-wire connection is mandatory with DC power supply.

Controllers with:
 0 to 10 Vdc
 2 to 10 Vdc
 0 to 20 mA
 4 to 20 mA

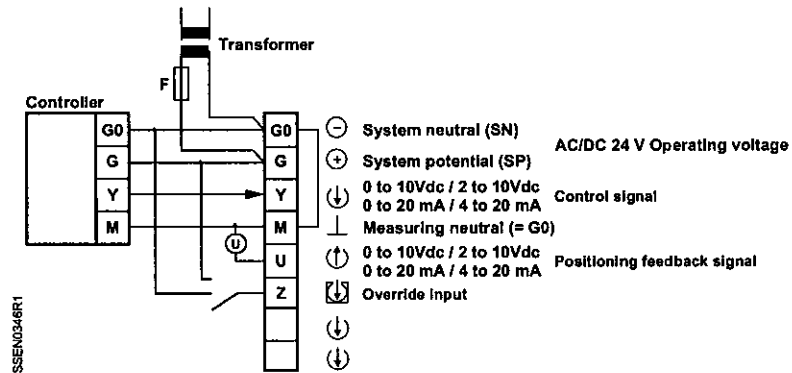

Figure 11.

Controllers with phase-cut
 0 to 20 Vdc

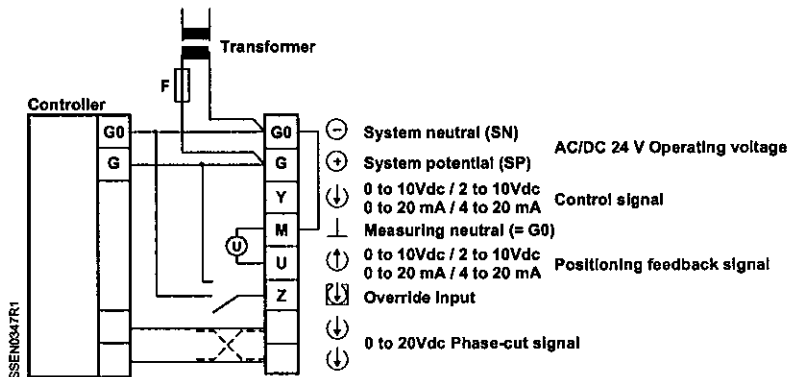

Figure 12.

Application Examples

This example shows only a schematic diagram, without installation-specific details.



CAUTION:

Valve may only be used in flow direction (A → AB). Note the flow direction.

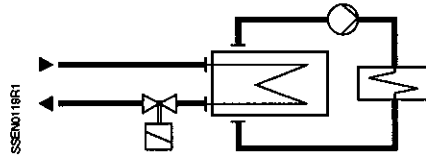

Figure 13. Direct Heating (Supply) System, Indirect Connection.

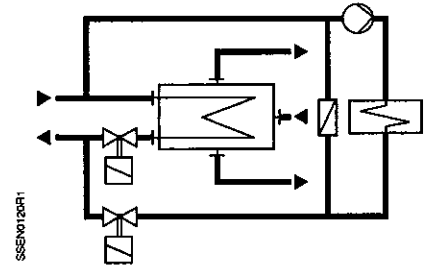

Figure 14. Direct Heating (Supply) System, Directly connected to Water-Heating System.

Service



CAUTION:

Do not disassemble the valve and actuator combination. This assembly is factory-calibrated, and should only be replaced by qualified personnel.

Always disconnect power before fitting or removing the electronics module.

- The low-friction and robust, maintenance-free design makes regular servicing unnecessary and ensures a long service life.
- The valve stem is sealed from external influences by a maintenance-free gland.
- If the red LED is lit, the electronics must be recalibrated or replaced.
- If the valve electronics are faulty, they must be replaced. After replacing the electronics, they must be recalibrated. See *Calibration*.
- If required, the circuit board can be replaced. Order Part Number ASE12.

Dimensions

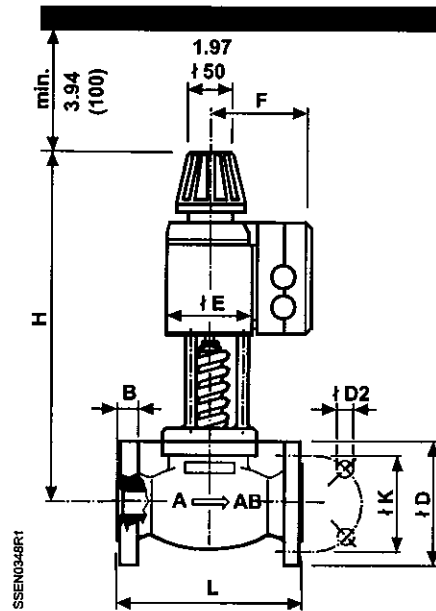

Figure 15. Dimensions in Inches (Millimeters).

Product Number	DN	L	ØD	ØD2	B	ØK	H	ØE	F	W lb (kg)
MVF461H15-0.6	15	5.12 (130)	3.74 (95)	0.16×0.55 (4×14)	0.55 (14)	2.56 (65)	13.4 (340)	3.15 (80)	4.53 (115)	18.3 (8.3)
MVF461H15-1.5	15	5.12 (130)	3.74 (95)	0.16×0.55 (4×14)	0.55 (14)	2.56 (65)	13.4 (340)	3.15 (80)	4.53 (115)	18.3 (8.3)
MVF461H15-3	15	5.12 (130)	3.74 (95)	0.16×0.55 (4×14)	0.55 (14)	2.56 (65)	13.4 (340)	3.15 (80)	4.53 (115)	18.3 (8.3)
MVF461H20-5	20	5.91 (150)	4.13 (105)	0.16×0.55 (4×14)	0.63 (16)	2.95 (75)	13.3 (339)	3.15 (80)	4.53 (115)	19.6 (8.9)
MVF461H25-8	25	6.30 (160)	4.53 (115)	0.16×0.55 (4×14)	0.63 (16)	3.35 (85)	13.6 (346)	3.15 (80)	4.53 (115)	22.1 (10.0)
MVF461H32-12	32	7.09 (180)	5.51 (140)	0.16×0.71 (4×18)	0.71 (18)	3.94 (100)	15.12 (384)	3.94 (100)	4.92 (125)	34.6 (15.7)
MVF461H40-20	40	7.87 (200)	5.91 (150)	0.16×0.71 (4×18)	0.71 (18)	4.33 (110)	15.79 (401)	3.94 (100)	4.92 (125)	39.2 (17.8)
MVF461H50-30	50	9.05 (230)	6.50 (165)	0.16×0.71 (4×18)	0.79 (20)	4.92 (125)	17.58 (449)	4.92 (125)	5.43 (138)	60.0 (27.2)

Information in this publication is based on current specifications. The company reserves the right to make changes in specifications and models as design improvements are introduced. Other product or company names mentioned herein may be the trademarks of their respective owners.
 © 2005 Siemens Building Technologies, Inc.